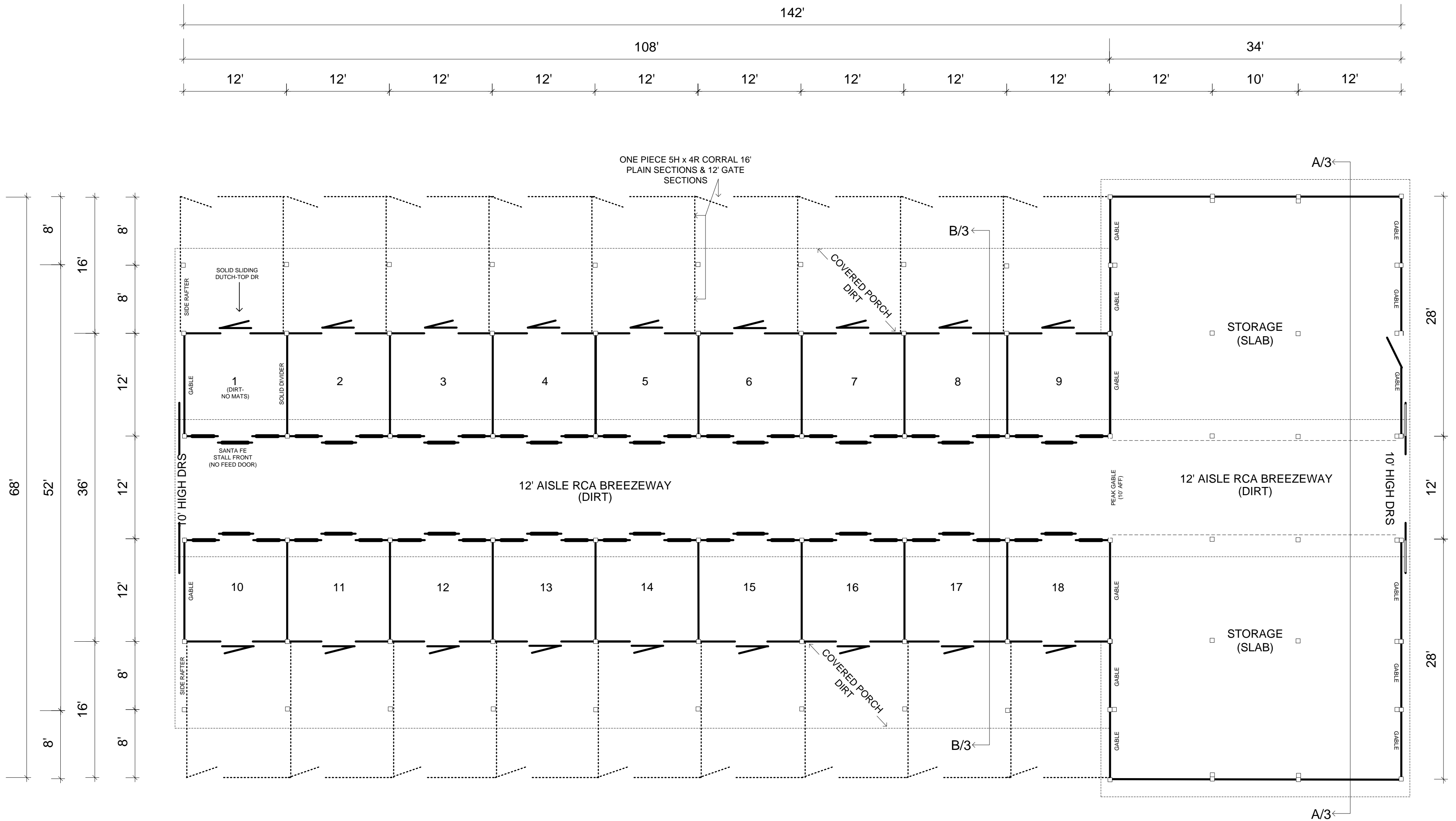

EXHIBIT "B"



NOT FOR
CONSTRUCTION:
SEE STRUCTURAL
PLANS FOR ALL FINAL
INFORMATION

LAYOUT DRAWING ACCEPTED BY: _____ DATE _____
 LAYOUT DRAWING ACCEPTED BY: _____ DATE _____
 SALES REPRESENTATIVE: _____ DATE _____



Designed Especially for:
DEPT. OF THE ARMY
B-TROOP @ BUFALO CORRAL
FORT HUACHUCA, AZ
 By: BARNOLOGIST
 (844) BARNS4U

P.O. NUMBER_101514-RC _____
 DATE_09-06-14 _____
 REVISED DATE_10-15-14 _____
 PAGE_1 OF_4 _____

CONCRETE
FOUNDATIONS ARE
NOT INCLUDED AND
ARE ONLY SHOWN
HEREIN FOR CLARITY

EXHIBIT "B"

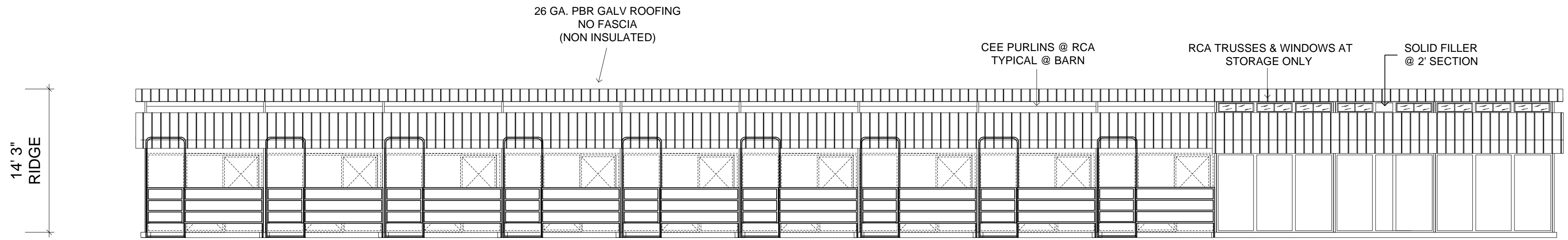

SIDE ELEVATION
(WITH CORRAL RUNS)

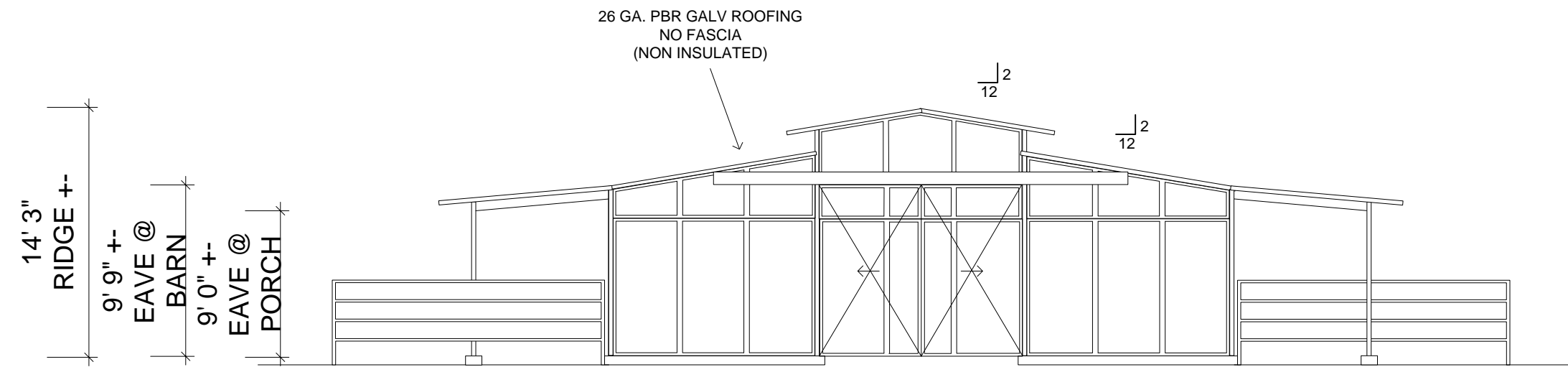

REAR ELEVATION

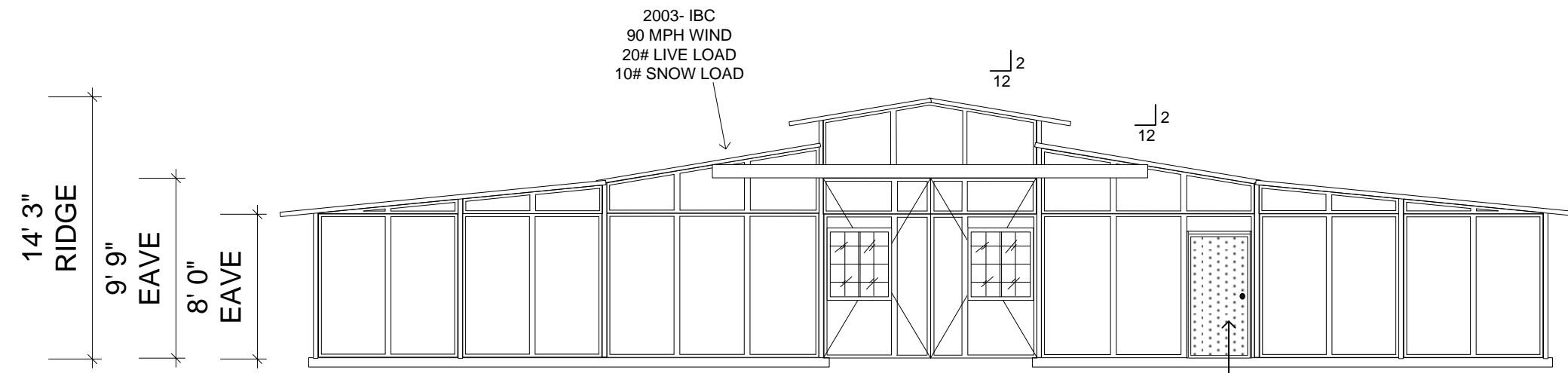

FRONT ELEVATION

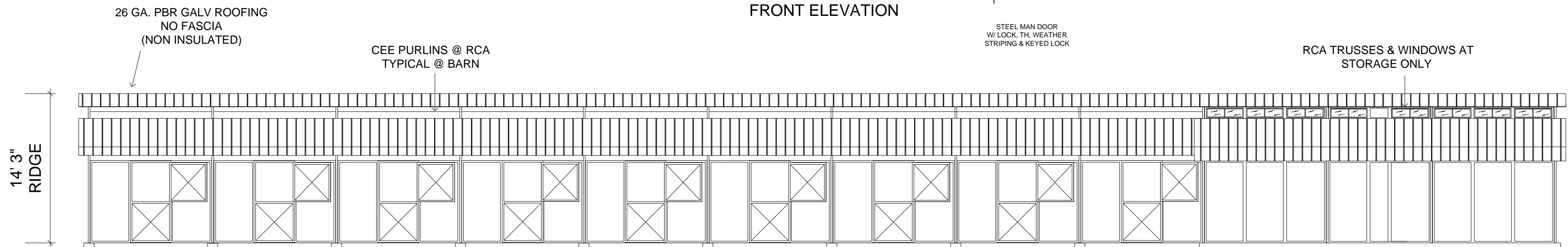

SIDE ELEVATION



NOT FOR
CONSTRUCTION:
SEE STRUCTURAL
PLANS FOR ALL FINAL
INFORMATION

LAYOUT DRAWING ACCEPTED BY: _____ DATE _____
LAYOUT DRAWING ACCEPTED BY: _____ DATE _____
SALES REPRESENTATIVE: _____ DATE _____



Designed Especially for:
DEPT. OF THE ARMY
B-TROOP @ BUFALO CORRAL
FORT HUACHUCA, AZ
By: BARNOLOGIST
(844) BARNS4U

P.O. NUMBER 101514-RC _____
DATE 09-06-14 _____
REVISED DATE 10-15-14 _____
PAGE 2 OF 4

CONCRETE
FOUNDATIONS ARE
NOT INCLUDED AND
ARE ONLY SHOWN
HEREIN FOR CLARITY

EXHIBIT "B"

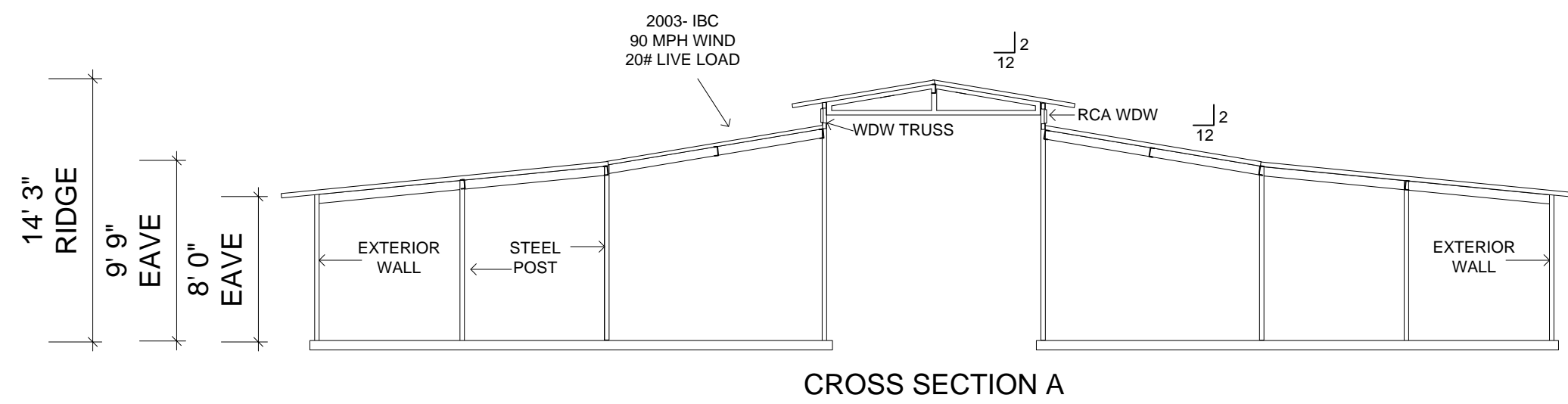
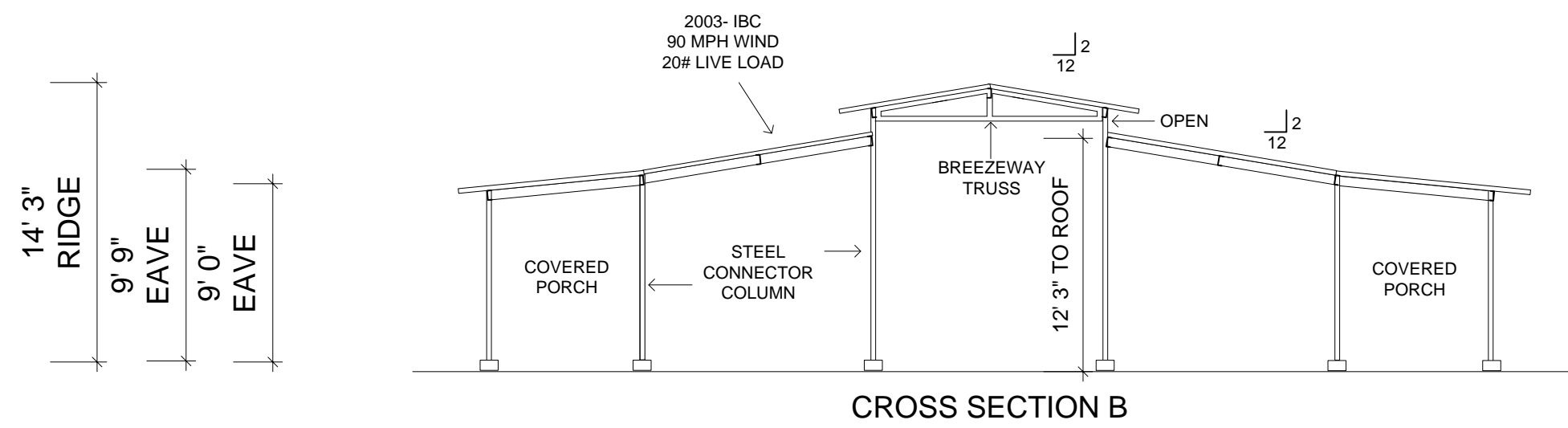
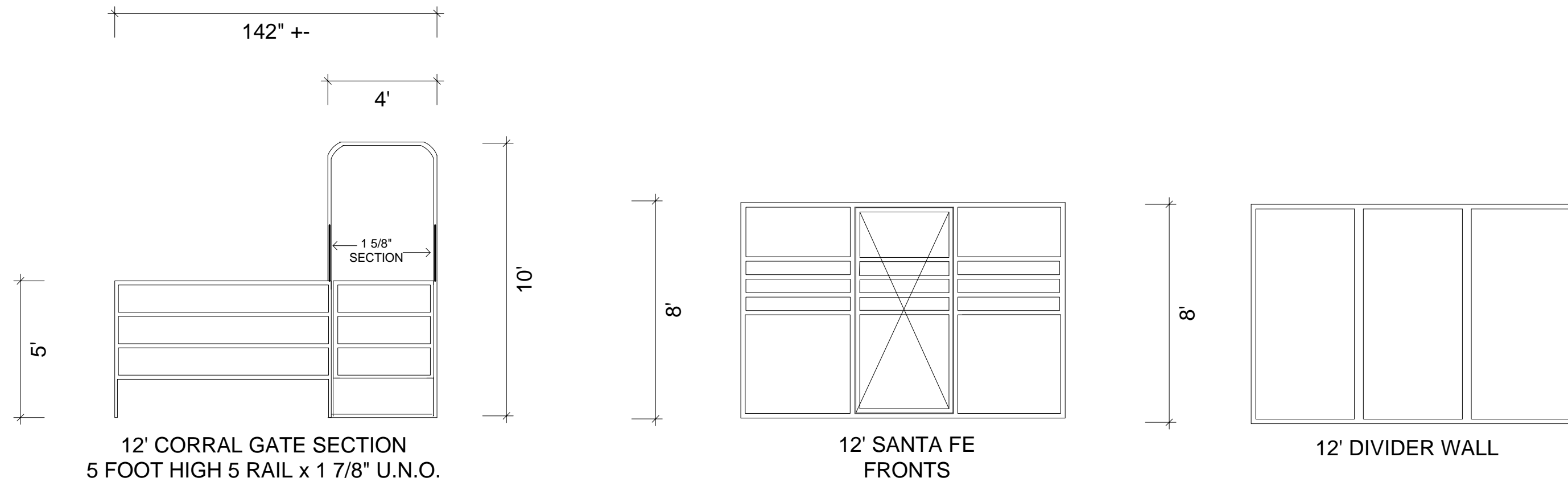

NOT FOR
CONSTRUCTION:
SEE STRUCTURAL
PLANS FOR ALL FINAL
INFORMATION

LAYOUT DRAWING ACCEPTED BY: _____ DATE _____
LAYOUT DRAWING ACCEPTED BY: _____ DATE _____
SALES REPRESENTATIVE: _____ DATE _____



Designed Especially for:
DEPT. OF THE ARMY
B-TROOP @ BUFALO CORRAL
FORT HUACHUCA, AZ
By: BARNOLOGIST
(844) BARNS4U

P.O. NUMBER 101514-RC _____
DATE 09-06-14 _____
REVISED DATE 10-15-14 _____
PAGE 3 OF 4 _____

CONCRETE
FOUNDATIONS ARE
NOT INCLUDED AND
ARE ONLY SHOWN
HEREIN FOR CLARITY

EXHIBIT "B"

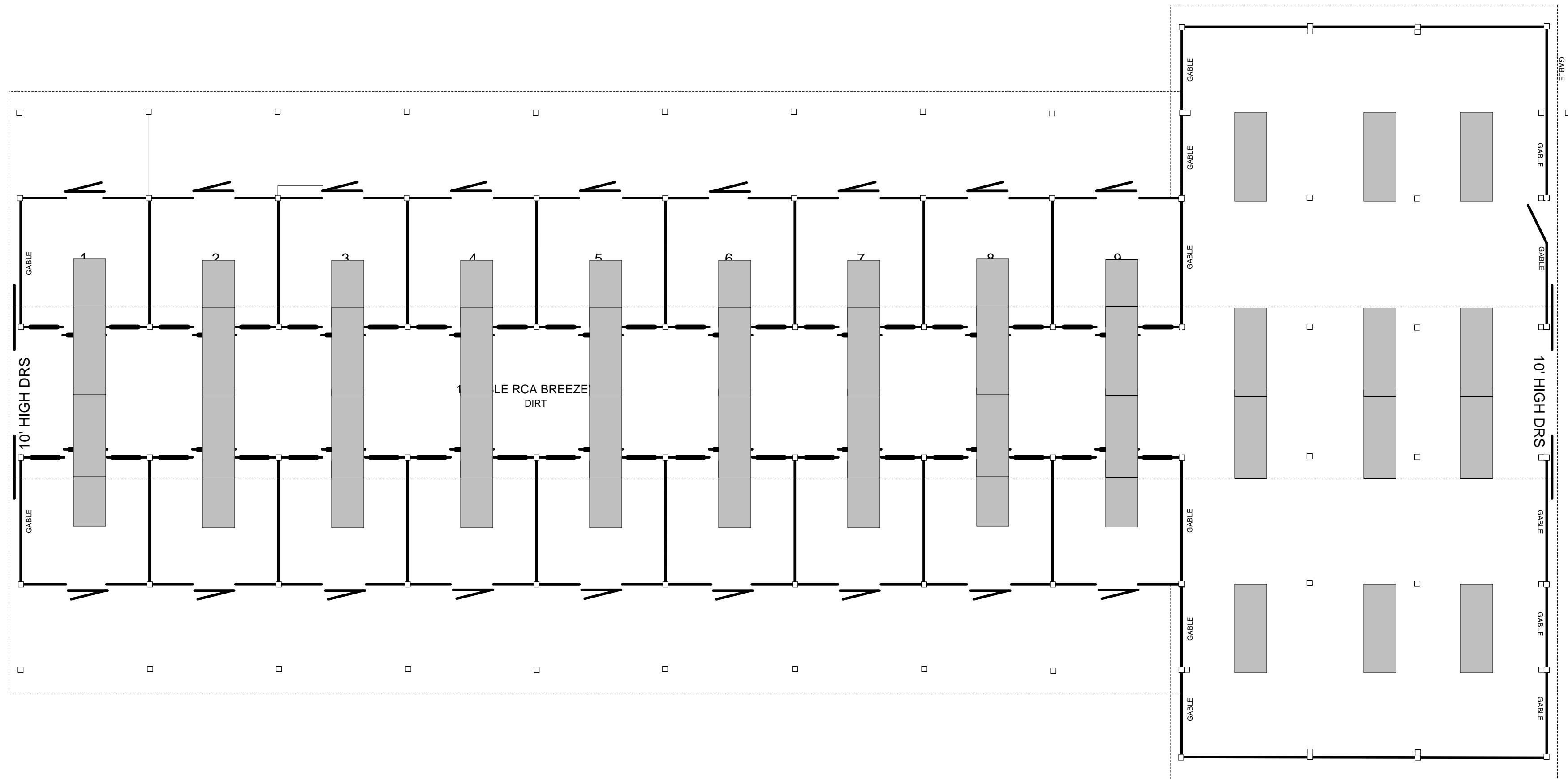

SKYLIGHT PANEL LAYOUT



NOT FOR
CONSTRUCTION:
SEE STRUCTURAL
PLANS FOR ALL FINAL
INFORMATION

LAYOUT DRAWING ACCEPTED BY: _____ DATE _____
LAYOUT DRAWING ACCEPTED BY: _____ DATE _____
SALES REPRESENTATIVE: _____ DATE _____



Designed Especially for:
DEPT. OF THE ARMY
B-TROOP @ BUFALO CORRAL
FORT HUACHUCA, AZ
By: BARNOLOGIST
(844) BARNS4U

P.O. NUMBER_101514-RC _____
DATE_09-06-14 _____
REVISED DATE_10-15-14 _____
PAGE_4 OF_4 _____

CONCRETE
FOUNDATIONS ARE
NOT INCLUDED AND
ARE ONLY SHOWN
HEREIN FOR CLARITY